

GF DAKOTA

grattugia cheese grater



- Corpo in alluminio anodizzato e fianchi in ABS antiurto.
- Generoso motore ventilato.
- Bocca grattugia in alluminio brillantato di grande capienza.
- Capiente e pratica vasca di raccolta prodotto in plexiglass trasparente.
- Rullo smontabile in acciaio inox.









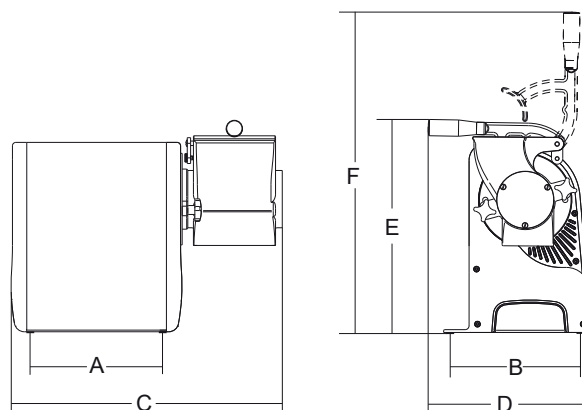



Versione CE con:

- Comandi 24 Volt con NVR.
- Dispositivo di sicurezza su vaschetta raccolta formaggio e leva.
- Anodized aluminum body and ABS shockproof sides.
- Generous ventilated motor.
- Mouth Aluminum grater large capacity polished.
- Capacious and practical bath product collection in transparent plexiglass.
- Stainless steel separable roller.

CE version with:

- 24 volt controls and NVR device.
- Safety microswitch on the receiving tray and the lever.



													
	watt/HP	r.p.m.	mm	mm	mm	mm	mm	mm	mm	mm	kg	mm	kg
GF Dakota	1ph - 750/1 3ph - 1.100/1.5	1ph/3ph	1.400	140x80	225	215	500	300	400	580	20	630x430x450	22